

Dermatome Bes

& Skin Graft Mesher

Battery + Electro Operated Surgical Power Tools

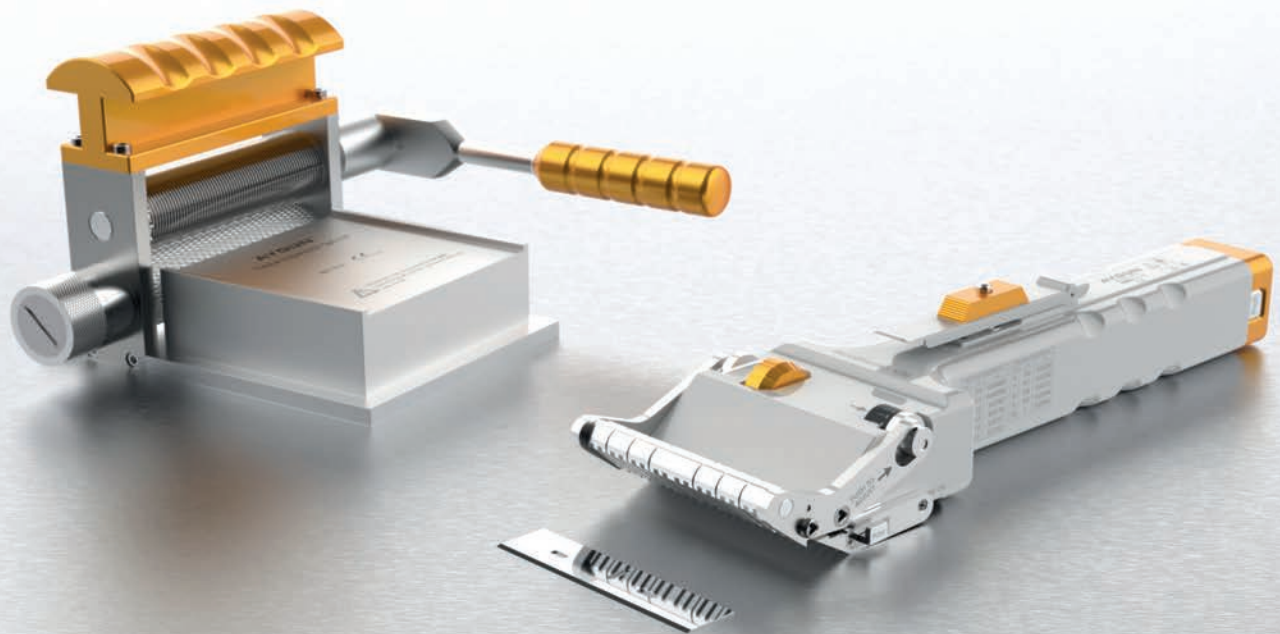

Precision In Every Layer
Masterful Grafting At Your Fingertips

Customizable Cutting Settings

Ergonomic Design

Enhanced Skin Grafting

 hermann
müller

AYGÜN®



Aygün
Surgical Motor Systems
Invest in your practice
Invest in your future



A leading manufacturer of Medical Devices Industry for over 36 years.

OUR HISTORY

AYGÜN, one of the leading establishments of Turkey in the field of Medical Industry, was founded in 1988. It manufactures Container Systems for sterilization, Surgical Motor Systems, Medical Illumination Systems and Single Use Medical Systems in its facility at Samsun Central Organized Industrial Zone.

AYGÜN meets the needs of significant part of Turkey as a result of its continuous R&D works and the capacity increasing. It manufactures its products in international standards and put them to the world market with a high

competitive power. More over with its integrated quality management system, it proves that it is a specialized establishment.

Besides being a manufacturer, AYGÜN is also a designer company and with its continuous product development works it increases number of its patents, on the other hand, is contributing career development of rising generation by acting as a school.

CONTENT

DERMATOME BATTERY SYSTEM

6 - 7

DERMATOME ELECTRO SYSTEM

8 - 9

DERMATOME BATTERY & ELECTRO SYSTEM

10 - 11

SKIN GRAFT MESHER & CARRIER

12 - 13

ADDITIONAL BASKETS AND STERILIZATION
CONTAINER ACCESSORIES

14 - 15



Dermatome Bes

SURGICAL POWER TOOLS



DERMATOME BATTERY SYSTEM

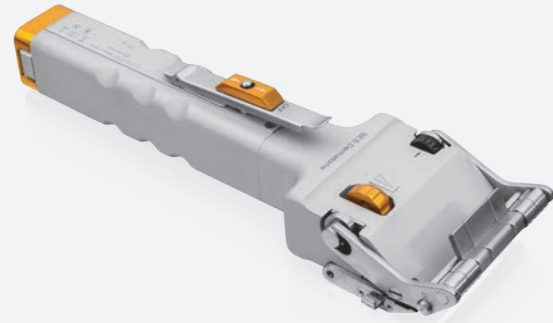

Code	M10-100
Dimension	300 x 90 x 55 mm
Weight	1190 g

Dermatome Handpiece

- Anodized Aluminium Body
- Autoclavable
- 16.000 cpm

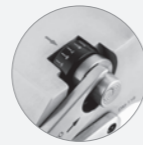

Dermatome Level	Cutting mm	Thickness inch
0	0.0	0.00000
1	0.1	0.00394
2	0.2	0.00787
3	0.3	0.0118
4	0.4	0.0157
5	0.5	0.0197
6	0.6	0.0236
7	0.7	0.0276
8	0.8	0.0315
9	0.9	0.0354
10	1	0.0394

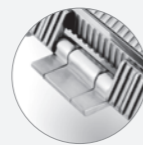

7 flaps give the ability to adjust cutting width from 9.75 mm to 78 mm (Width of middle flap is 19,5 and others are 9,75)



Cutting speed adjust button with safe lock.

Battery Operated Set Content	
M10-100	Dermatome Handpiece
M10-102	Rechargeable Battery
M10-103	Charger Unit
M10-104	Battery Loading Case
M7-105	Spare Blades x10 ea.
K3-762	Basket Lid
K3-2731	Basket
K6-3340	Perforated lid
K6-307	Box, non perforated
K2-740	Paper Filter x100 pcs

- User friendly, battery powered high torque motor design.
- No need to connect electric supply or compressed air.
- Removable special batteries make steam sterilization possible.
- Ergonomic and weight balanced design make it easy to handle.
- 7 flaps give the ability to adjust cutting width from 9.75 mm to 78 mm. (Width of middle flap is 19,5 and others are 9,75)
- Easy blade change mechanism designed to insert the blade only one side thus incorrect blade insertion is avoided.
- Cutting speed can be adjusted by only one finger.
- Safe lock mechanism prevents from unwanted operation of the motor.

SET EQUIPMENT



Code	Piece	Dimension
M7-105	Non Sterile Blade - 1 pack (10 pcs)	81 x 18,5 x 0,40 mm
M7-105T	Non Sterile Blade - 1 pc	



Code	Dimension	Weight
M10-103	200 x 200 x 120 mm	2500 g

Charger unit for 2 battery (without battery)

- Mains voltage 100-240 Volts, 50-60 Hz, 0.9 A
- Charging current 1.5 A
- Charging voltage 9.6 Volts
- Protections: Short circuit / Overload / Over voltage



Code	M10-104
Dimension	55 x 55 x 55 mm
Weight	60 g

Autoclavable sterile funnel for aseptic battery loading



Code	Dimension	Weight
M10-102	136 x 32 x 32 mm	270 g

Rechargeable Ni-MH battery

- Not autoclavable
- Battery capacity: 1.3 Ah
- Voltage: 9.6 Volts

STERILIZATION CONTAINER, BASKETS AND ACCESSORIES



Code	K6-307
Dimension	475 x 272 x 138 mm

Box, non perforated

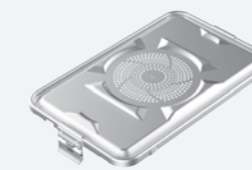

Code	K6-3340
Dimension	460 x 285 mm

Perforated Lid Standard plus model

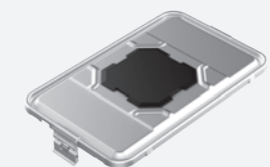

Code	K8-340V
Dimension	460 x 285 mm

B3 Barrier Lid Valve System



Code	K3-762
Dimension	407 x 256 x 4 mm

Lid

Code	K3-2731
Dimension	405 x 253 x 110 mm

Basket, with silicone fixations



Code	K2-740
-------------	--------

Single use paper filter x100 pcs
• With indicator



Code	M14-816
-------------	---------

Spray oil

Dermatome Bes

SURGICAL POWER TOOLS



DERMATOME ELECTRO SYSTEM

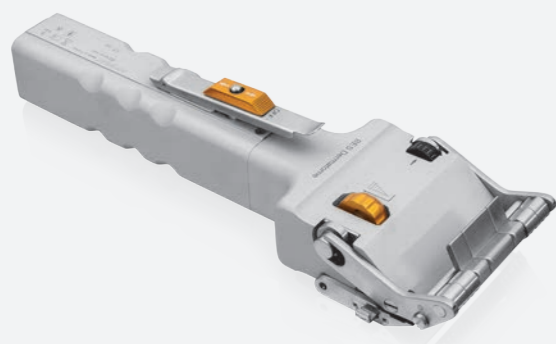

Code	M10-110
Dimension	283 x 90 x 55 mm
Weight	1090 g

- Dermatome Handpiece**
- Anodized Aluminium Body
 - Autoclavable
 - 16.000 cpm

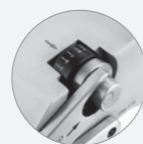

Dermatome Level	Cutting mm	Thickness inch
0	0.0	0.00000
1	0.1	0.00394
2	0.2	0.00787
3	0.3	0.0118
4	0.4	0.0157
5	0.5	0.0197
6	0.6	0.0236
7	0.7	0.0276
8	0.8	0.0315
9	0.9	0.0354
10	1	0.0394

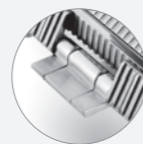

7 flaps give the ability to adjust cutting width from 9.75 mm to 78 mm (Width of middle flap is 19,5 and others are 9,75)



Cutting speed adjust button with safe lock.

Electro Operated Set Content	
M10-110	Dermatome Handpiece
M10-112	Power Supply
M10-113	Fixing socket with cable
M7-105	Spare Blades x10 ea.
K3-762	Basket Lid
K3-2731	Basket
K6-3340	Perforated lid
K6-307	Box, non perforated
K2-740	Paper Filter x100 pcs

SET EQUIPMENT



Code	Piece	Dimension
M7-105	Non Sterile Blade - 1 pack (10 pcs)	81 x 18,5 x 0,40 mm
M7-105T	Non Sterile Blade - 1 pc	



Code	Dimension	Weight
M10-112	140 x 128 x 89 mm	510 g

Power supply for direct corded use

- Mains voltage 100-240 Volts, 50-60 Hz
- Supply voltage 12 Volts, current 5 A
- Protections: Short circuit / Overload



Code	Weight
M10-113	480 g

Power cord for direct corded use

- Autoclavable
- Steam sterilisable at 2 bar 134°
- 4 m. cable length

STERILIZATION CONTAINER, BASKETS AND ACCESSORIES



Code	K6-307
Dimension	475 x 272 x 138 mm

Box, non perforated

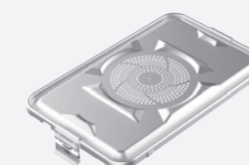

Code	K6-3340
Dimension	460 x 285 mm

Perforated Lid
Standard plus model

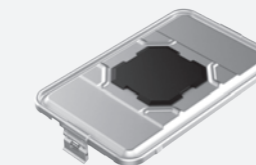

Code	K8-340V
Dimension	460 x 285 mm

B3 Barrier Lid
Valve System



Code	K3-762
Dimension	407 x 256 x 4 mm

Lid

Code	K3-2731
Dimension	405 x 253 x 110 mm

Basket, with silicone fixations



Code	K2-740
------	--------

Single use paper filter x100 pcs
• With indicator



Code	M14-816
------	---------

Spray oil

Dermatome Bes

SURGICAL POWER TOOLS



DERMATOME BATTERY & ELECTRO SYSTEM

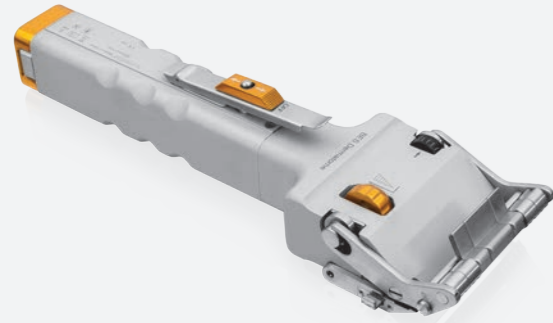

Code	M10-100
Dimension	300 x 90 x 55 mm
Weight	1190 g

- Dermatome Handpiece**
- Anodized Aluminium Body
 - Autoclavable
 - 16.000 cpm

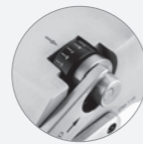

Dermatome Level	Cutting mm	Thickness inch
0	0.0	0.00000
1	0.1	0.00394
2	0.2	0.00787
3	0.3	0.0118
4	0.4	0.0157
5	0.5	0.0197
6	0.6	0.0236
7	0.7	0.0276
8	0.8	0.0315
9	0.9	0.0354
10	1	0.0394

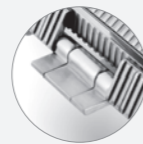

7 flaps give the ability to adjust cutting width from 9.75 mm to 78 mm (Width of middle flap is 19,5 and others are 9,75)



Cutting speed adjust button with safe lock.

Battery & Electro Operated Set Content

M10-100	Dermatome Handpiece
M10-102	Rechargeable Battery
M10-105	Charger Unit
M10-104	Battery Loading Case
M10-113	Fixing socket with cable
M7-105	Spare Blades x10 ea.
K3-762	Basket Lid
K3-2731	Basket
K6-3340	Perforated lid
K6-307	Box, non perforated
K2-740	Paper Filter x100 pcs

SET EQUIPMENT



Code	Piece	Dimension
M7-105	Non Sterile Blade - 1 pack (10 pcs)	81 x 18,5 x 0,40 mm
M7-105T	Non Sterile Blade - 1 pc	



Code	Dimension	Weight
M10-105	230 x 230 x 120 mm	3200 g

Power supply and Charger unit for 2 battery (without battery)

- Mains voltage 100-240 Volts, 50-60 Hz, 1.5 A
- Charging current 1.5 A
- Charging voltage 9.6 Volts
- Power supply 12 Volts, 5 A
- Protections: Short circuit / Overload / Over voltage



Code	Weight
M10-113	480 g

Power cord for direct corded use

- Autoclavable
- Steam sterilisable at 2 bar 134°
- 4 m. cable length



Code	M10-102
Dimension	136 x 32 x 32 mm
Weight	270 g

Rechargeable Ni-MH battery

- Not autoclavable
- Battery capacity: 1.3 Ah
- Voltage: 9.6 Volts



Code	M10-104
Dimension	55 x 55 x 55 mm
Weight	60 g

Autoclavable sterile funnel for aseptic battery loading

STERILIZATION CONTAINER, BASKETS AND ACCESSORIES



Code	K6-307
Dimension	475 x 272 x 138 mm

Box, non perforated

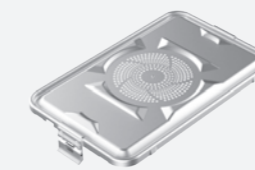

Code	K6-3340
Dimension	460 x 285 mm

Perforated Lid Standard plus model

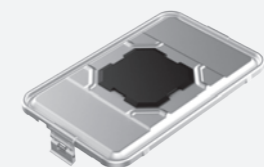

Code	K8-340V
Dimension	460 x 285 mm

B3 Barrier Lid Valve System



Code	K3-762
Dimension	407 x 256 x 4 mm

Lid

Code	K3-2731
Dimension	405 x 253 x 110 mm

Basket, with silicone fixations



Code	K2-740
-------------	--------

Single use paper filter x100 pcs
• With indicator



Code	M14-816
-------------	---------

Spray oil

Dermatome Bes

SURGICAL POWER TOOLS

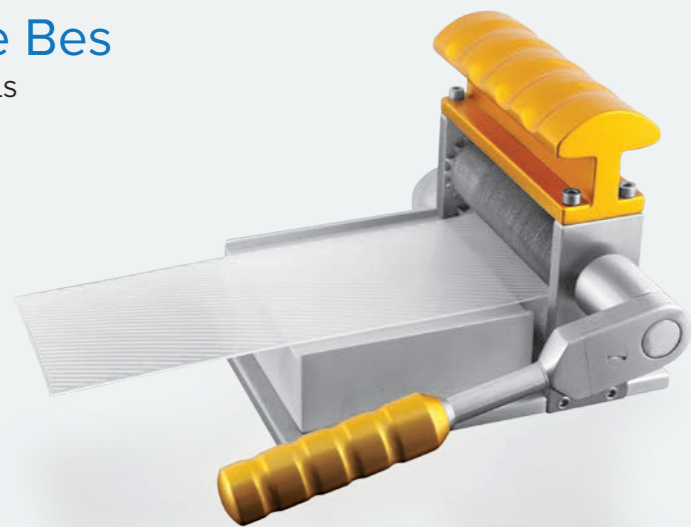

SKIN GRAFT MESHER



Code	M11-500
Dimension	205 x 165 x 120 mm
Weight	4000 g

Skin Graft Mesher

Skin Graft Mesher Set Content

M11-500	Skin Graft Mesher
M11-600	Skin graft carrier > 1,5:1 (Box of 20)
M11-605	Skin graft carrier > 3:1 (Box of 20)
K3-762	Lid
K3-755-S1	Basket
K6-3630	Perforated lid
K6-608	Box, non perforated
K2-740	Paper Filter x100 pcs



Guides for Graft Carrier



Ratchet Handle for Easy Operation

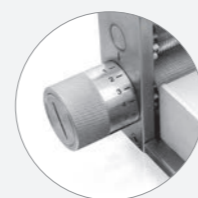

Graft Thickness Adjustment (0-1,5 mm)

- Single cutter cuts skin graft into geometrical shaped mesh & enlarges skin surface.
- Graft expansion predetermined by graft carrying plates, eliminating need to change the cutter during operation.
- Continuous feed design prevents graft carrying plate from being loaded incorrectly and allows multiple plates to be used without interruption.
- Graft thickness adjustment feature allows expansion on thin and thick grafts.
- Easy availability of replacement parts.

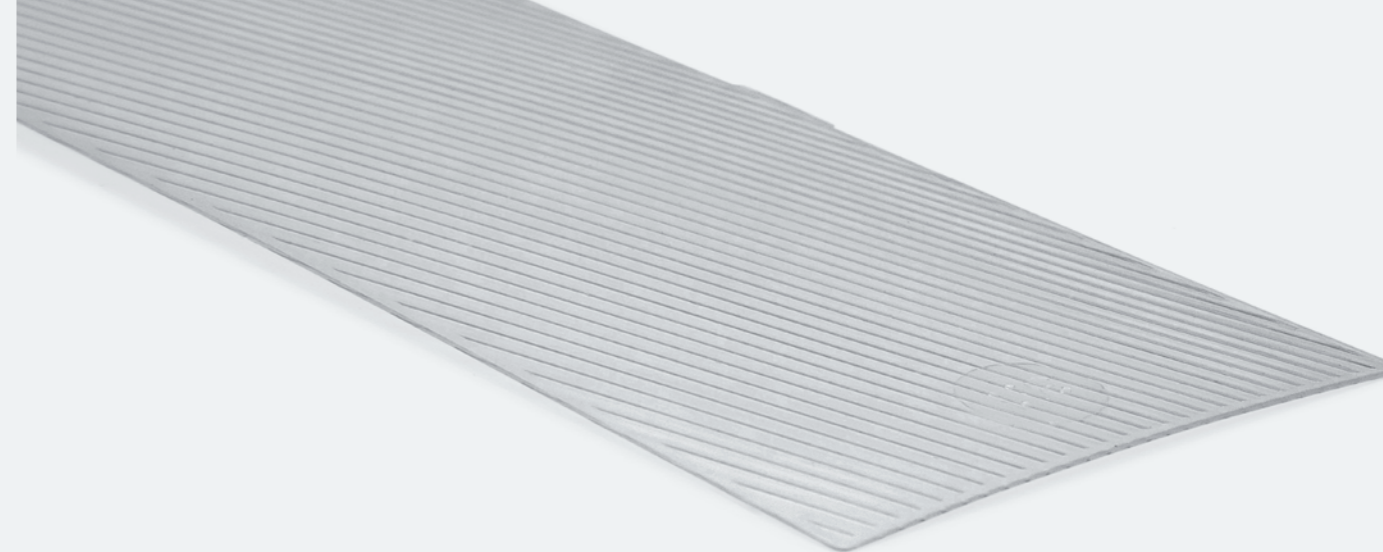

CARRIER

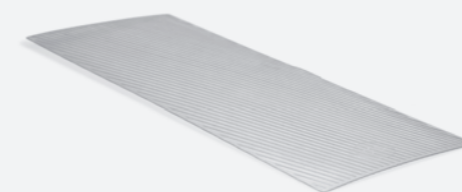

Code		Dimension
M11-600	Skin graft carrier > 1,5:1 (Box of 20)	200 x 80 x 1 mm
M11-600T	Skin graft carrier > 1,5:1 (1 pc)	
M11-605	Skin graft carrier > 3:1 (Box of 20)	
M11-605T	Skin graft carrier > 3:1 (1 pc)	

STERILIZATION CONTAINER, BASKETS AND ACCESSORIES



Code	K6-608
Dimension	310 x 272 x 185 mm

Box, non perforated

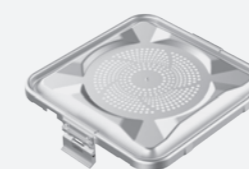

Code	K6-3630
Dimension	295 x 280 mm

Perforated Lid
Standard plus model

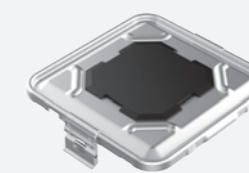

Code	K8-630V
Dimension	295 x 280 mm

B3 Barrier Lid
Valve System

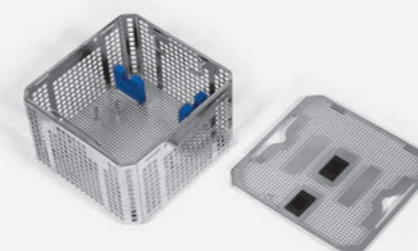

Code	K3-763
Dimension	247 x 256 x 4 mm

Lid

Code	K3-755-S1
Dimension	244 x 253 x 110 mm

Basket, with silicone fixations



Code	K2-740
------	--------

Single use paper filter x100 pcs
• With indicator

ADDITIONAL BASKETS AND STERILIZATION CONTAINER ACCESSORIES

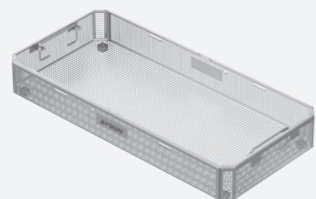

Code	K3-742
Dimension	540 x 253 x 80 mm

Basket made from stainless steel sheet (with stand)

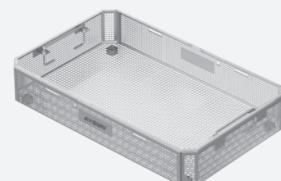

Code	K3-750
Dimension	405 x 253 x 80 mm

Basket made from stainless steel sheet (with stand)

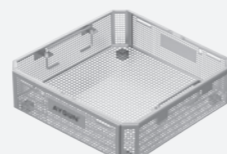

Code	K3-754
Dimension	244 x 253 x 80 mm

Basket made from stainless steel sheet (with stand)

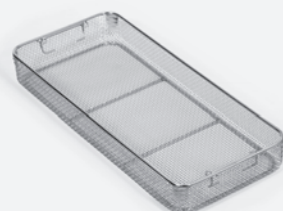

Code	K2-462
Dimension	540 x 245 x 70 mm

Wire Basket

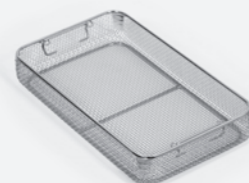

Code	K2-1502
Dimension	405 x 245 x 70 mm

Wire Basket

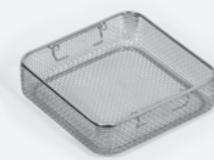

Code	K2-492
Dimension	246 x 246 x 70 mm

Wire Basket

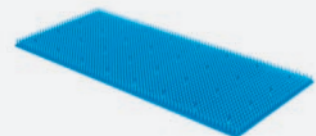

Code	K2-526
Dimension	520 x 230 mm

Silicone Mat



Code	K2-524
Dimension	380 x 230 mm

Silicone Mat



Code	K2-527
Dimension	230 x 220 mm

Silicone Mat



Code	K1-900
------	--------

Modular Auto Lock Mechanism (2 Pcs)





FACTORY
Kerimbeyosb Mah.
Yaşardođu Cad. No: 76/1
55330, Tekkeköy/Samsun/Türkiye

T : +90 (362) 266 66 80
F : +90 (362) 266 93 30

www.aygun.com
aygun@aygun.com

All rights reserved.No part of this catalog may
be reproduced in any form without the written
permission from AYGUN